



A COMPANY OF STPI GROUP

E210, ES210, & EA210

Military Specified

Meets MIL-PRF-83536

General Characteristics

Number of Poles:

Dimensions:

Weight:

-Mounting Code 09:

2 Form C (2PDT)

1.025" x 0.525" x 1.010"

(26.0mm x 13.3mm x 25.7mm)

0.10 lb. (46 grams)

0.12 lb. (54.5 grams)

Switching Characteristics

Operate Time @ 25°C:

-EA210:

Release Time @ 25°C:

-Mounting Code 09:

-EA210:

Bounce Time:

Mechanical Life:

10 ms Max.

20 ms Max.

10 ms Max.

20 ms Max.

50 ms Max.

1 ms Max.

400,000 Cycles

Environmental Characteristics

Temperature Range:

Vibration (Sinusoidal):

Shock (any axis):

Seal:

-70°C to +125°C

30g 10-3,000 Hz

200g, 6 ms

Hermetic (1×10^{-8} atm cm³/s)

Electrical Characteristics

Contact Voltage Drop (at rated resistive load)

-Initial:

-After Guaranteed Life:

Dielectric Strength

Coil to Case @ Sea Level

-Initial @ 60 Hz:

-After Life Test @ 60 Hz:

All Other Points @ Sea Level

-Initial @ 60 Hz:

-After Life Test @ 60 Hz:

Coil to Case @ Sea Level (Mounting Code 09)

-Initial @ 60 Hz:

-After Life Test @ 60 Hz:

All Other Points @ Sea Level (Mounting Code 09)

-Initial @ 60 Hz:

-After Life Test @ 60 Hz:

Insulation Resistance

-Initial:

-After Life Tests:

-Mounting Code 09:

-Max. Leakage Current (Mounting Code 09):

Back EMF (Transient Voltage):

150 mV Max.

175 mV Max.

1,000 Vrms

1,000 Vrms

1,250 Vrms

1,000 Vrms

1,050 Vrms

1,050 Vrms

1,500 Vrms

1,250 Vrms

100 MΩ Min, @ 500 Vdc

50 MΩ Min, @ 500 Vdc

100 MΩ Min, @ 500 Vdc

100 μA RMS

42 Vdc Max. (ES210 Only)

Contact Rating (Amps)

Type of Load (High Level)	Cycles x 10 ³	28 Vdc	115 Vac 400 Hz 1 Phase	115 Vac 50/60 Hz 1 Phase	115/200 Vac 400 Hz 3 Phase	115/200 Vac 50/60 Hz 3 Phase
Resistive	100	10	10	2.5	10	2.5
Inductive	20	8	8	N/A	8	N/A
Inductive	10	N/A	N/A	2.5	N/A	2.5
Motor	100	4	4	2	4	2
Lamp	100	2	2	1	N/A	N/A

Circuit Diagram

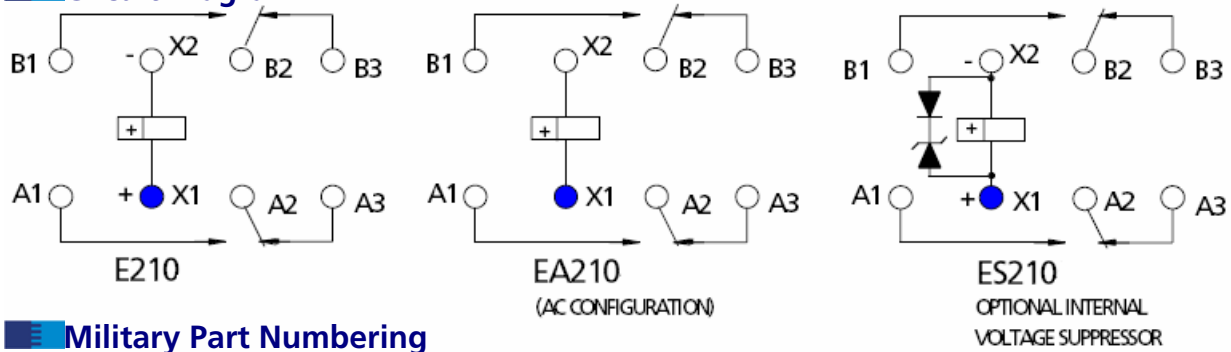

Military Part Numbering

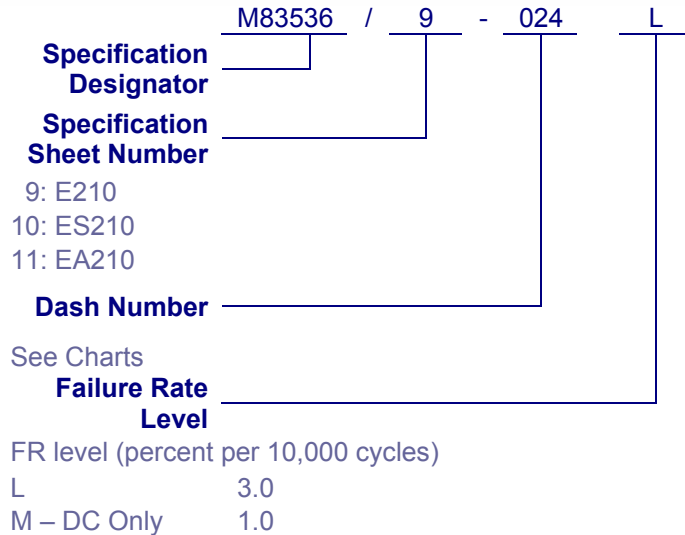

QPL Part Numbering

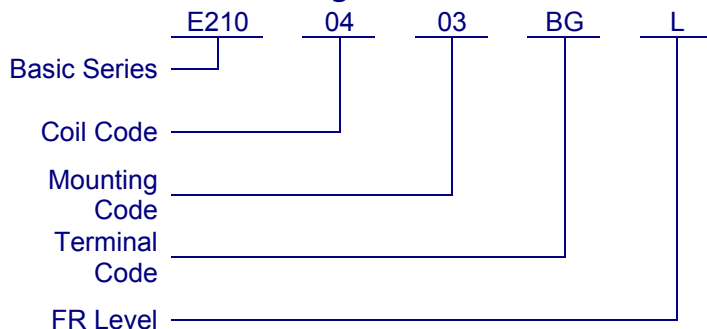



A COMPANY OF STPI GROUP

Dash Numbers – Specification Sheet Number 9: E210

Dash Number	Coil Code	Mount	Terminals	Coil Voltage	Max Pickup Voltage at 25°C	Max Pickup Voltage at 125°C	Max Hold Voltage at 125°C	Min Dropout Voltage at -70°C	Coil Resistance (Ω, +/- 10% at 25°C)
010	02	01	ET	12	6.5	9	4.5	0.5	80
011	02	01	AT	12	6.5	9	4.5	0.5	80
012	02	01	BG	12	6.5	9	4.5	0.5	80
013	02	03	ET	12	6.5	9	4.5	0.5	80
014	02	03	AT	12	6.5	9	4.5	0.5	80
015	02	03	BG	12	6.5	9	4.5	0.5	80
016	02	07	ET	12	6.5	9	4.5	0.5	80
017	02	07	AT	12	6.5	9	4.5	0.5	80
018	02	07	FT	12	6.5	9	4.5	0.5	80
019	04	01	ET	28	14	18.7	7	1.5	320
020	04	01	AT	28	14	18.7	7	1.5	320
021	04	01	BG	28	14	18.7	7	1.5	320
022	04	03	ET	28	14	18.7	7	1.5	320
023	04	03	AT	28	14	18.7	7	1.5	320
024	04	03	BG	28	14	18.7	7	1.5	320
025	04	07	ET	28	14	18.7	7	1.5	320
026	04	07	AT	28	14	18.7	7	1.5	320
027	04	07	FT	28	14	18.7	7	1.5	320

Dash Numbers – Specification Sheet Number 10: ES210

Dash Number	Coil Code	Mount	Terminals	Coil Voltage	Max Pickup Voltage at 25°C	Max Pickup Voltage at 125°C	Max Hold Voltage at 125°C	Min Dropout Voltage at -70°C	Coil Resistance (Ω, +/- 10% at 25°C)
010	02	01	CT	12	6.5	9	4.5	0.5	80
011	02	01	AT	12	6.5	9	4.5	0.5	80
012	02	01	BG	12	6.5	9	4.5	0.5	80
013	02	03	CT	12	6.5	9	4.5	0.5	80
014	02	03	AT	12	6.5	9	4.5	0.5	80
015	02	03	BG	12	6.5	9	4.5	0.5	80
016	02	07	CT	12	6.5	9	4.5	0.5	80
017	02	07	AT	12	6.5	9	4.5	0.5	80
018	02	07	FT	12	6.5	9	4.5	0.5	80
019	04	01	CT	28	14	18.7	7	1.5	320
020	04	01	AT	28	14	18.7	7	1.5	320
021	04	01	BG	28	14	18.7	7	1.5	320
022	04	02	CT	28	14	18.7	7	1.5	320
023	04	02	AT	28	14	18.7	7	1.5	320
024	04	02	BG	28	14	18.7	7	1.5	320
025	04	03	CT	28	14	18.7	7	1.5	320
026	04	03	AT	28	14	18.7	7	1.5	320
027	04	03	FT	28	14	18.7	7	1.5	320
028	00	09	GG	28	14	18.7	7	1.5	320
038*	28	03	BG	28	14	18.7	7	1.5	320

*This relay is supplied without internal Arc Barriers and is not rated for AC loads

Dash Numbers – Specification Sheet Number 11: EA210

Dash Number	Coil Code	Mount	Terminals	Coil Voltage / Freq.	Max Pickup Voltage at 25°C	Max Pickup Voltage at 125°C	Max Hold Voltage at 125°C	Min Dropout Voltage at -70°C	Coil Current (A, Max. at 25°C)
001	07	04	AT	115 / 400	73	90	30	5	.04
002	07	04	CG	115 / 400	73	90	30	5	.04
005	08	04	ET	115 / 50/60	73	90	40	5	.04
006	08	04	AT	115 / 50/60	73	90	40	5	.04
007	08	04	CG	115 / 50/60	73	90	40	5	.04
008	07	08	AT	115 / 400	73	90	30	5	.04
009	08	08	AT	115 / 50/60	73	90	40	5	.04
010	08	02	ET	115 / 50/60	73	90	40	5	.04
011	08	02	AT	115 / 50/60	73	90	40	5	.04
012	07	09	CG	115 / 400	75	95	30	5	.04

Mounting Styles

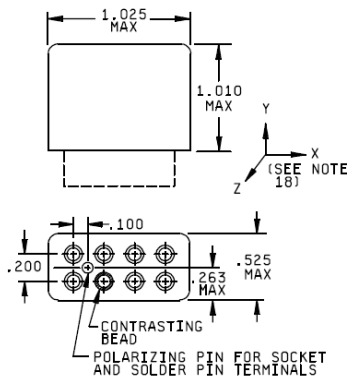

Mount 01:
No Mount - DC

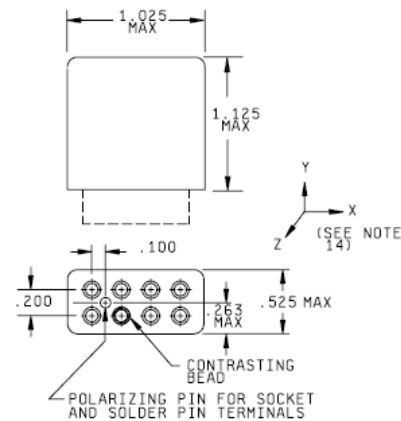

Mount 02:
No Mount - AC

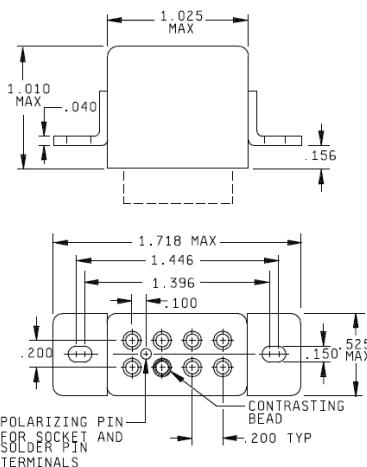

Mount 02 & 03:
Raised Vertical Flange
Mount - DC

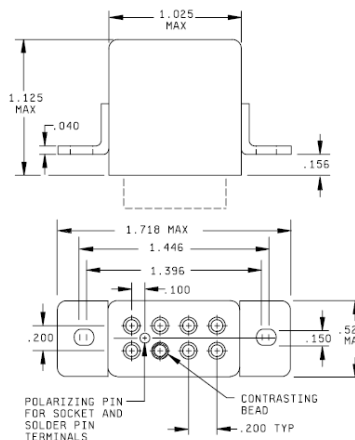

Mount 04:
Raised Vertical Flange
Mount - AC

Mounting Styles (Continued)

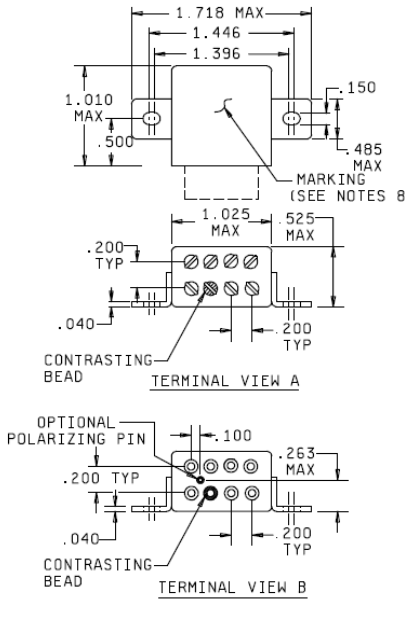

Mount 07:
Horizontal Flange
Mount - DC

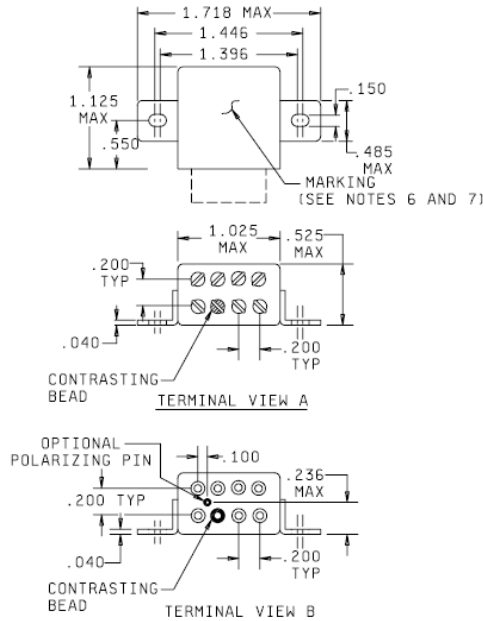

Mount 08:
Horizontal Flange
Mount - AC

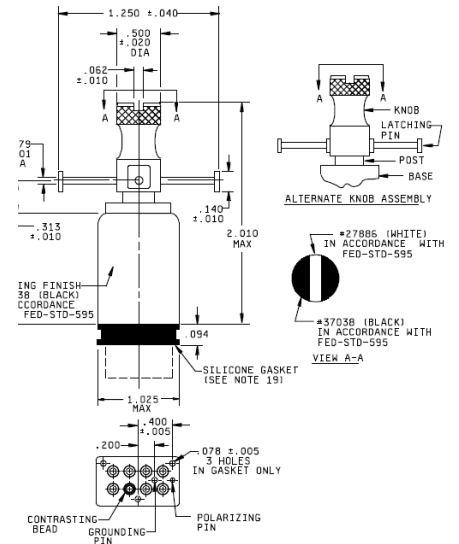

Mount 09:
Track Mount B

Terminal Styles

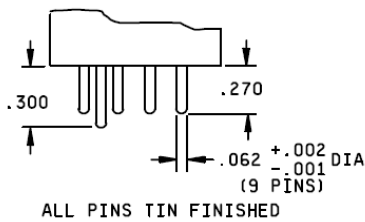

Terminal CT & ET:
Tin Plated Solder Pin - DC

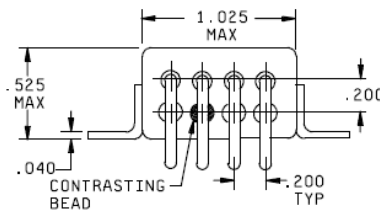

Terminal FT:
Tin Plated 90° Solder
Pin - DC

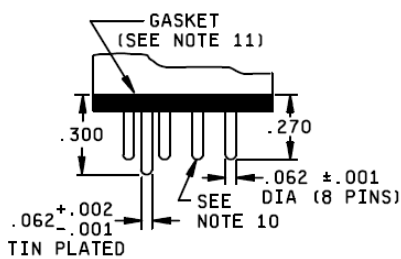
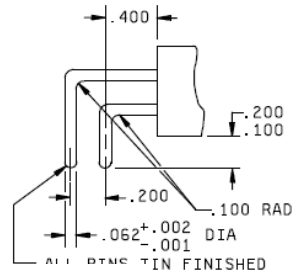

Terminal BG:
Gold Plated Plug in - DC

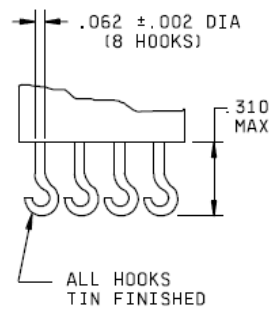

Terminal AT:
Tin Plated Solder Hook -
AC & DC

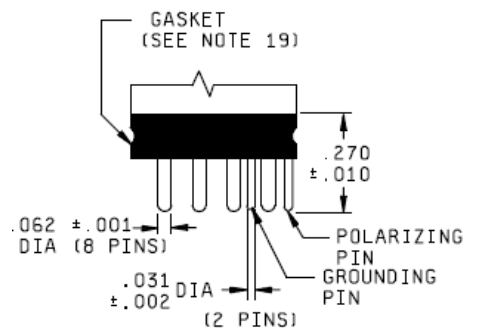

Terminal GG:
Track Mount Plug in - DC

Terminal Styles (Continued)

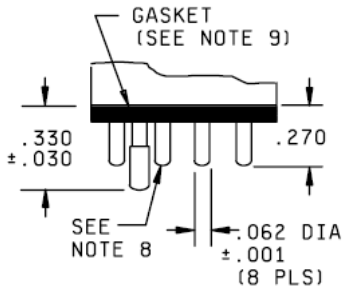

Terminal CG:
Gold Plated Plug in - AC

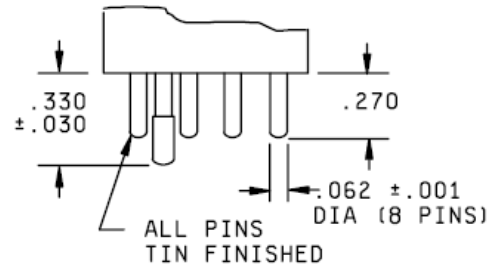

Terminal ET:
Tin Plated Solder Pin - AC

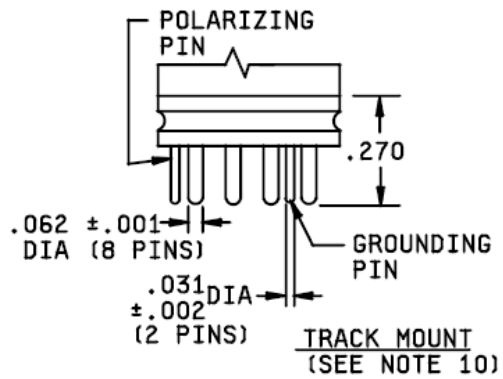

Terminal CG:
Track Mount Plug in - AC